

SELLE - BOCCHETTONI - FLANGE

SADDLES - UNIONS - FLANGES

FLANGIA

FLANGE



ARTICOLO	MISURE mm	BUTT WELDING - SDR11	
CODE	SIZES mm		
FLG 32	32	FLG 160 T	160
FLG 40	40	FLG 200 T	200
FLG 50	50	FLG 250 T	250
FLG 63	63	FLG 315 T	315
FLG 75	75		
FLG 90	90		
FLG 110	110		
FLG 125	125		
FLG 160	160		

SPECIFICHE TECNICHE

TECHNICAL SPECIFICATIONS

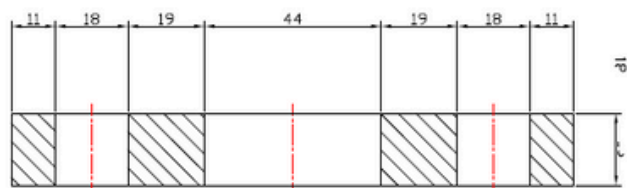

CODE	weight (g)
FLG 32	534

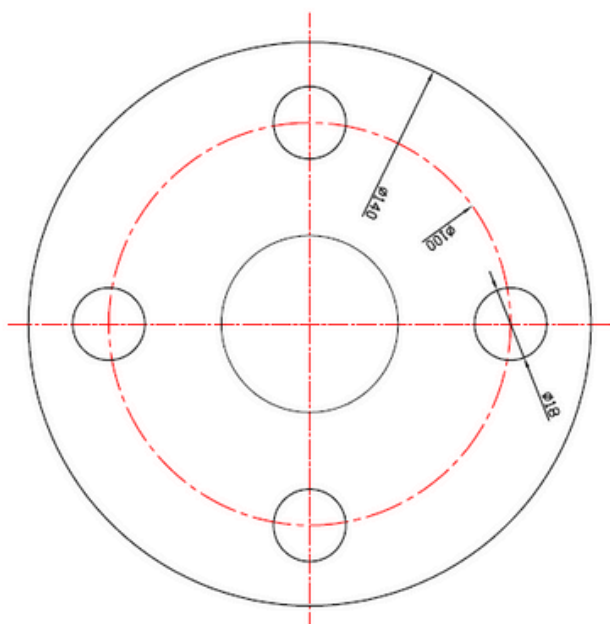

SELLE - BOCCHETTONI - FLANGE

SADDLES - UNIONS - FLANGES

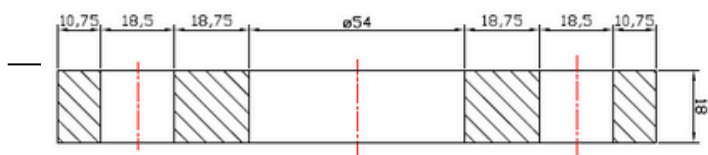

CODE	weight (g)
FLG 40	618

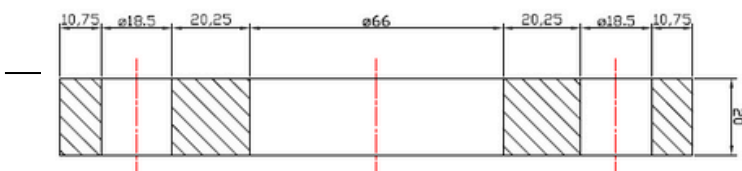
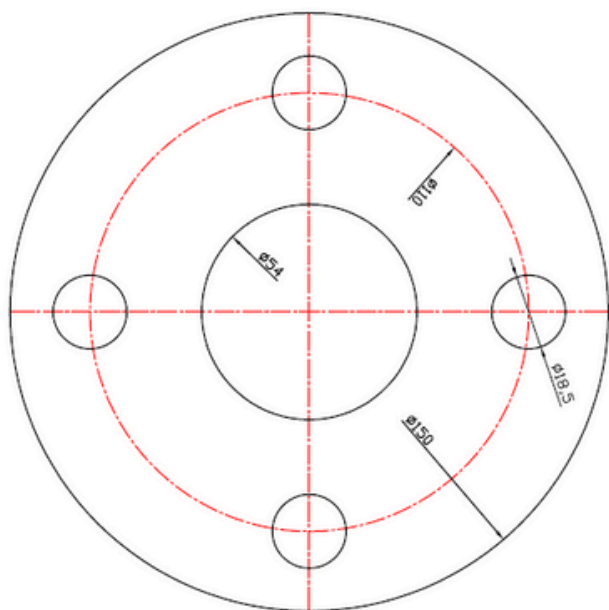

CODE	weight (g)
FLG 50	708

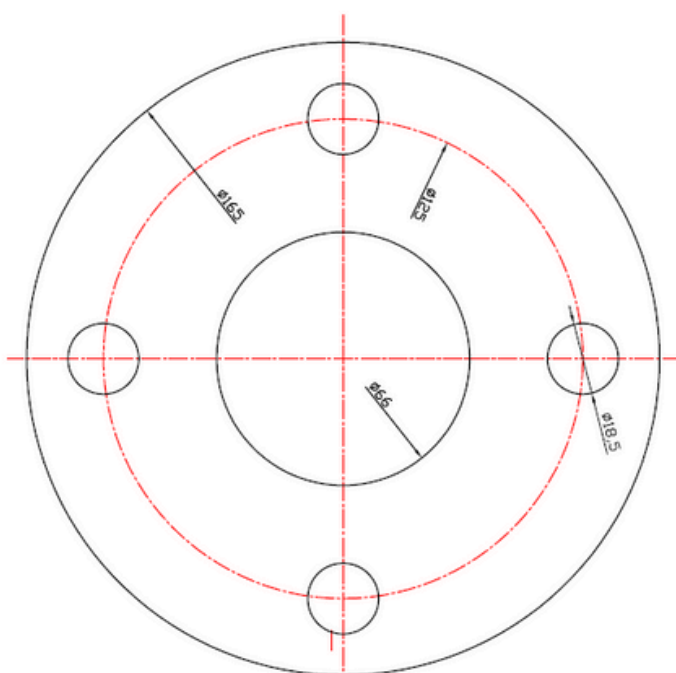

SELLE - BOCCHETTONI - FLANGE

SADDLES - UNIONS - FLANGES



CODE	weight (g)
FLG 63	844

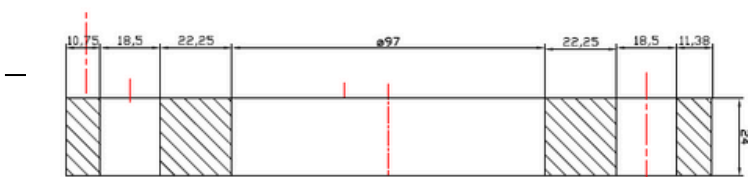
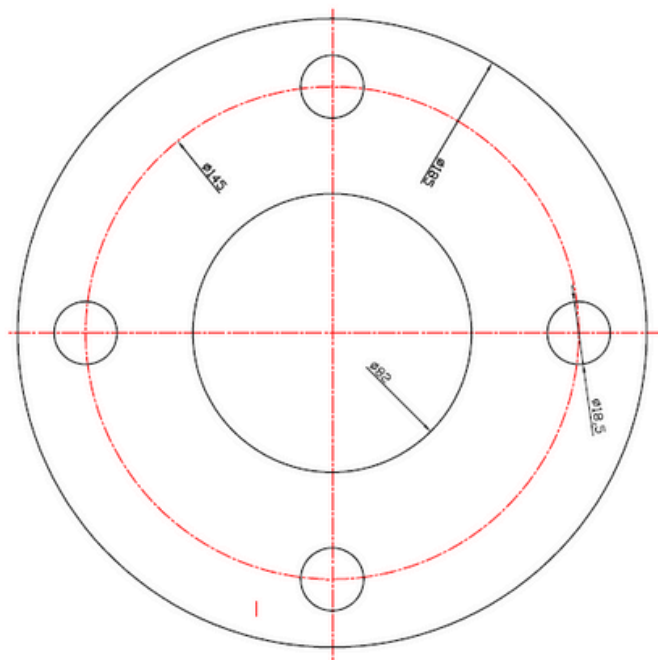

CODE	weight (g)
FLG 75	1014

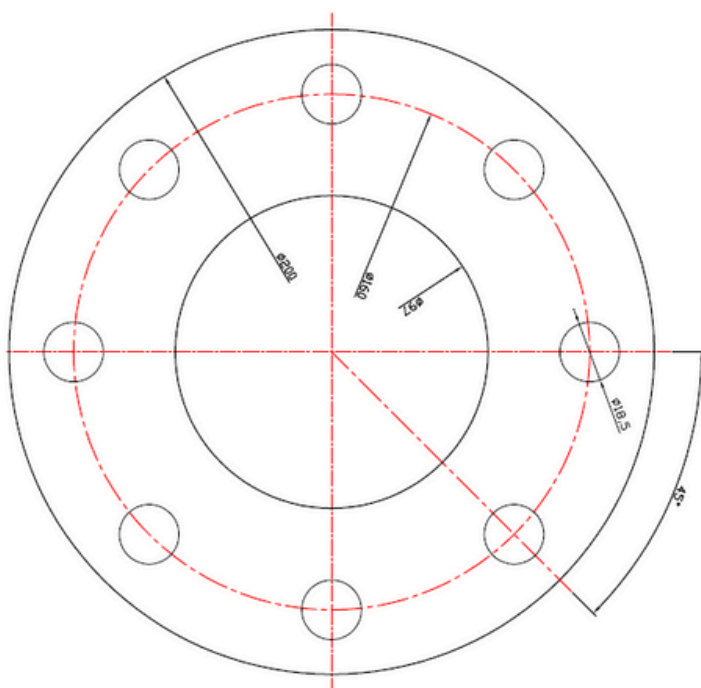

SELLE - BOCCHETTONI - FLANGE

SADDLES - UNIONS - FLANGES

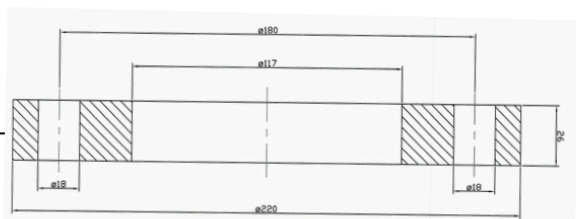

CODE	weight (g)
FLG 90	1184

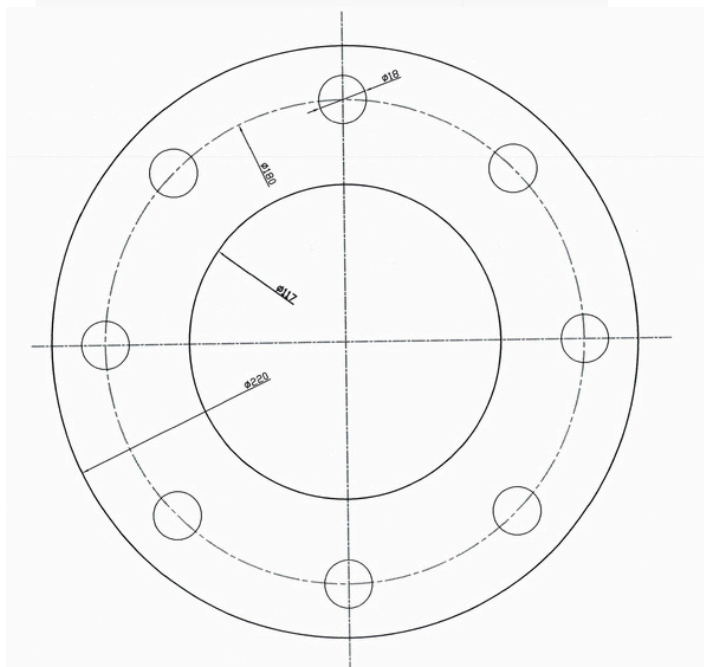

CODE	weight (g)
FLG 110	900

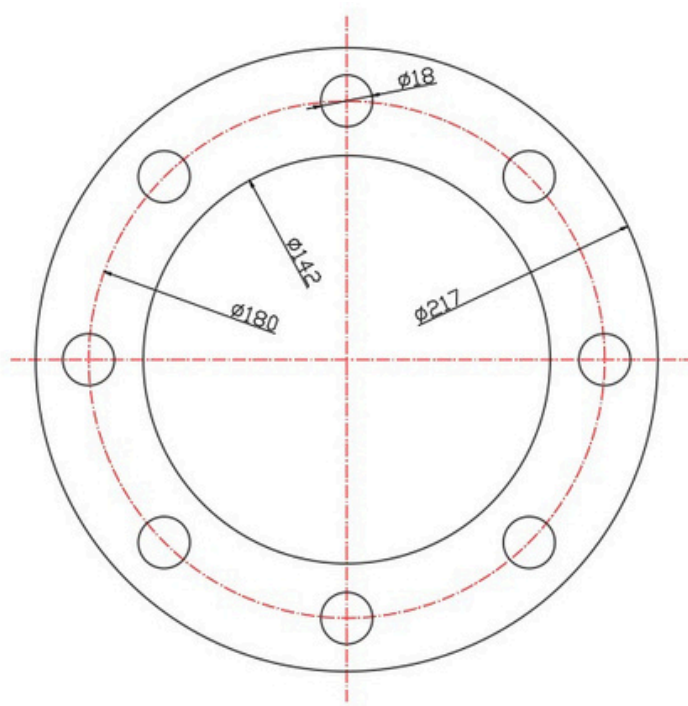

SELLE - BOCCHETTONI - FLANGE

SADDLES - UNIONS - FLANGES

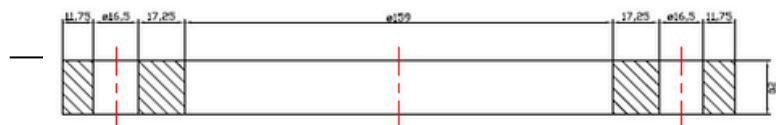

CODE	weight (g)
FLG 125	1300

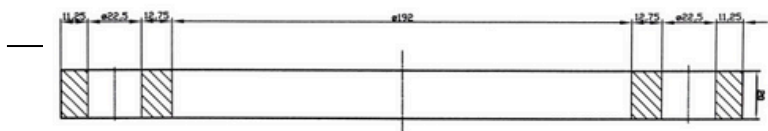
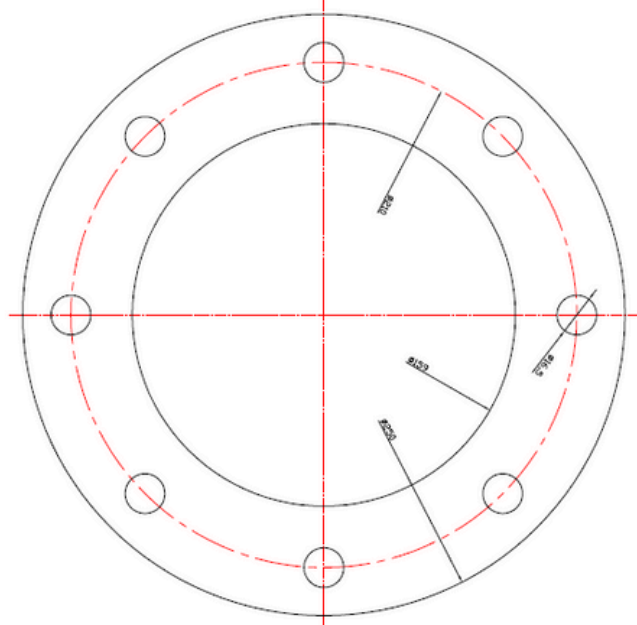

CODE	weight (g)
FLG 160	1500

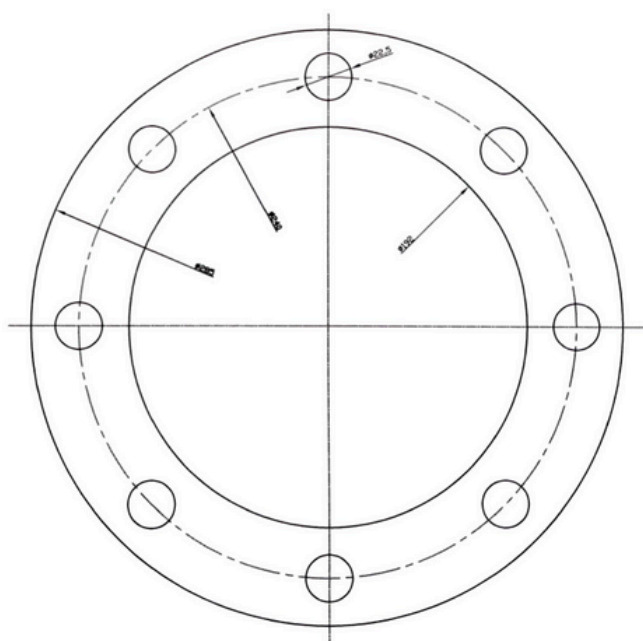

SELLE - BOCCHETTONI - FLANGE

SADDLES - UNIONS - FLANGES

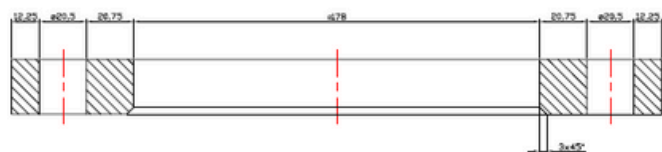

BUTT WELDING	
CODE	weight (g)
FLG 160T	7800

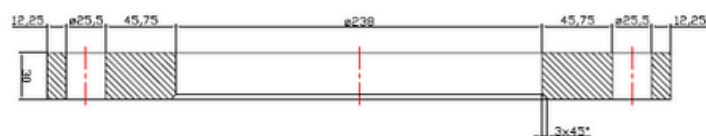
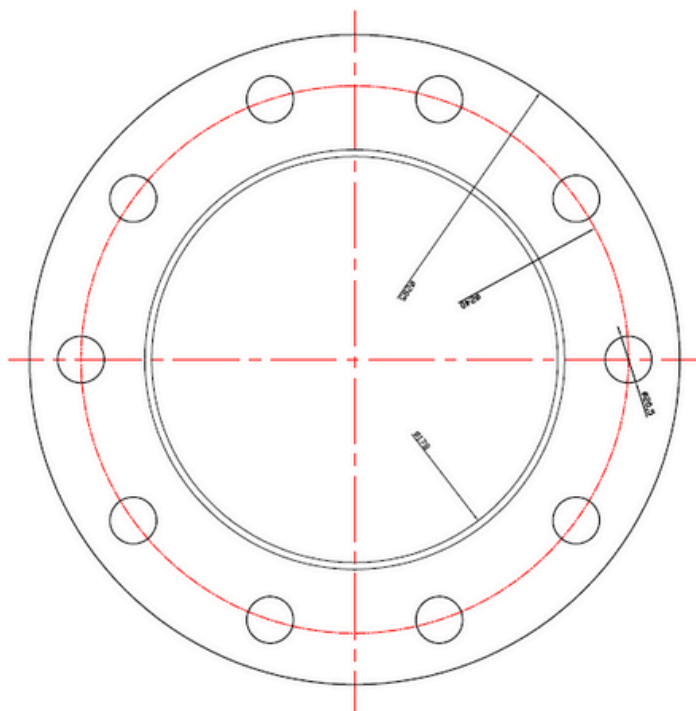

BUTT WELDING	
CODE	weight (g)
FLG 200T	8600

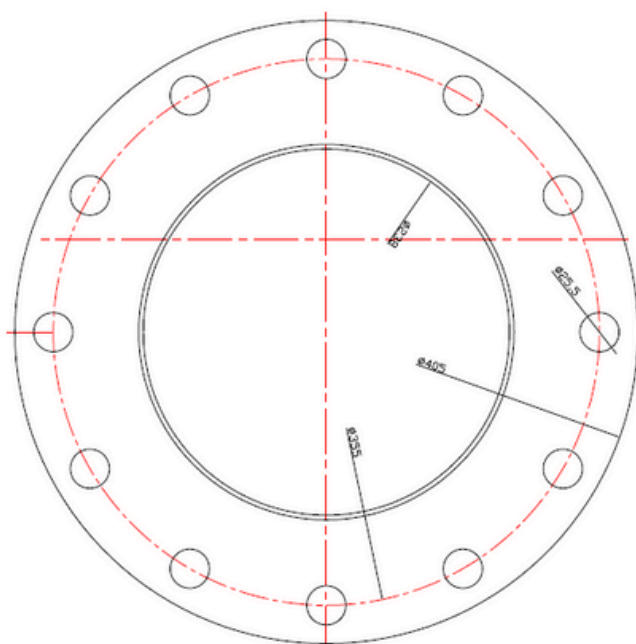

SELLE - BOCCHETTONI - FLANGE

SADDLES - UNIONS - FLANGES

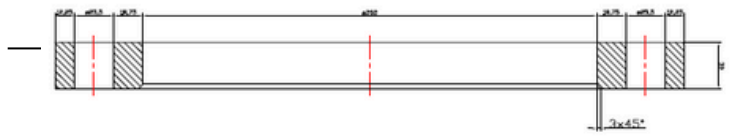

BUTT WELDING

CODE	weight (g)
FLG 250T	14100

